

G6

M1 (B3, B5)

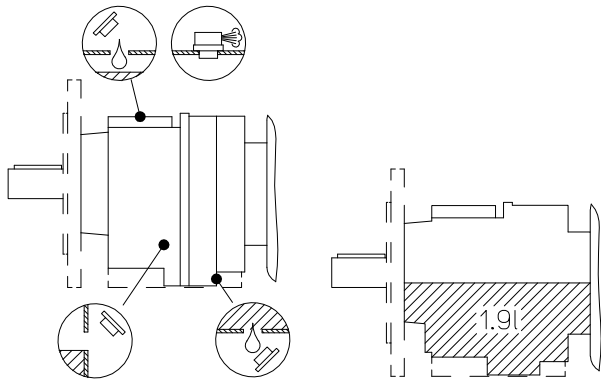

M2 (V6, V3)

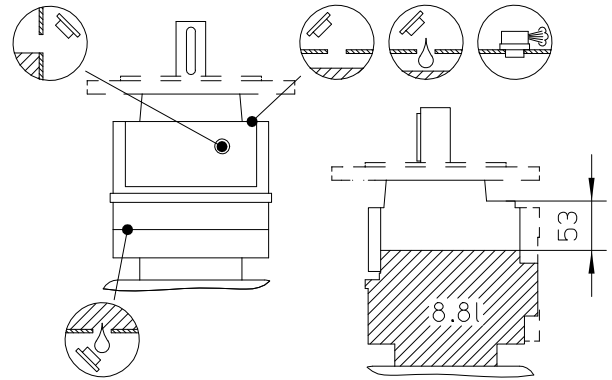

M3 (B8, B5/180)

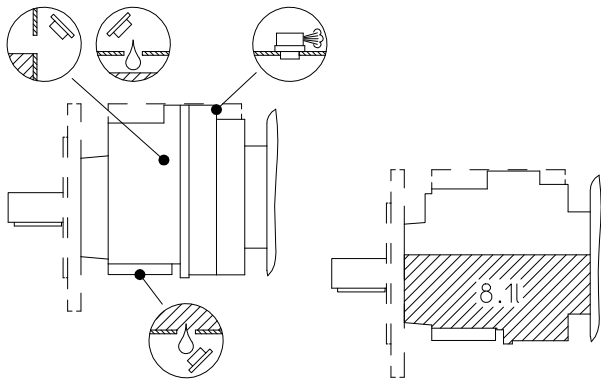

M4 (V5, V1)

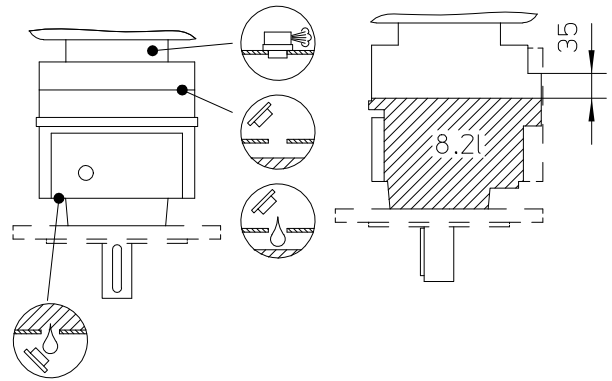

M5 (B6, B5/90)

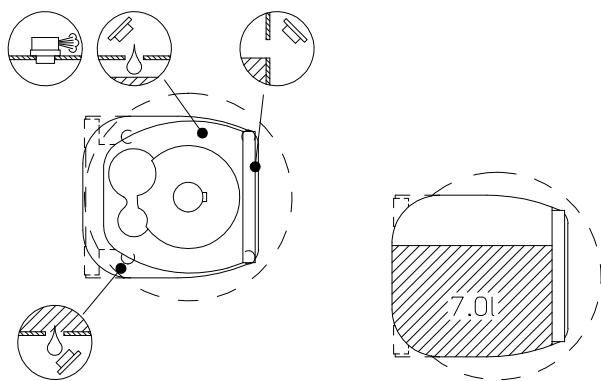

M6 (B7, B5/270)

