

# K5

## M1 (H1)

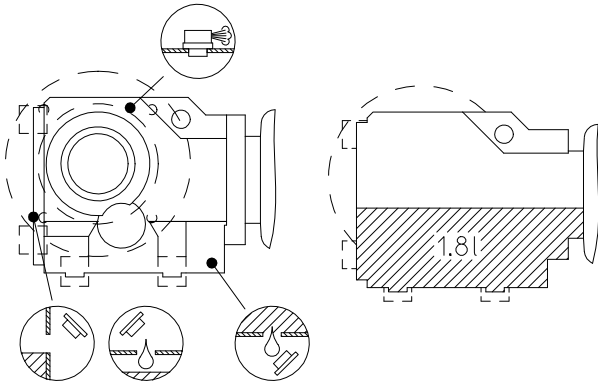

## M2 (H4)

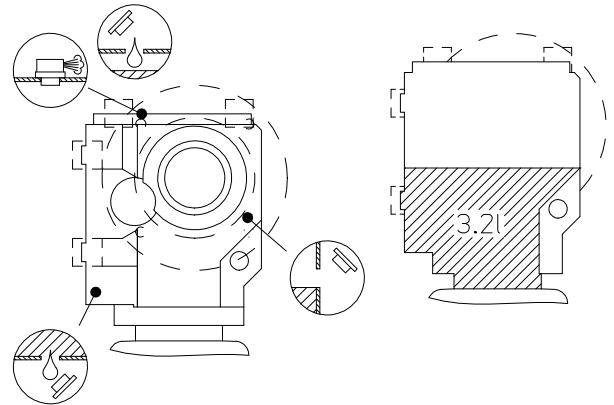

## M3 (H2)

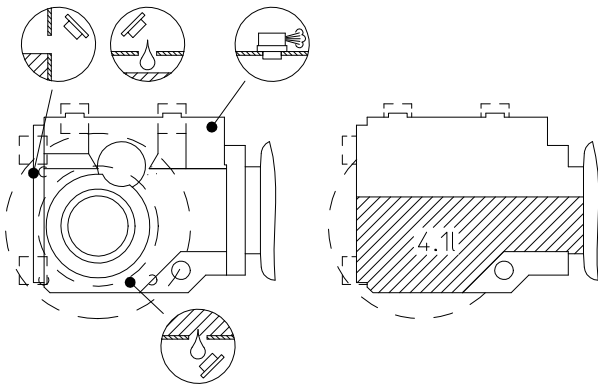

## M4 (H3)

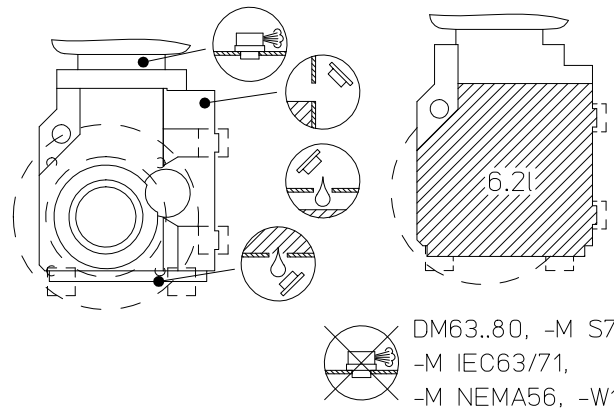

 DM63..80, -M S70  
-M IEC63/71,  
-M NEMA56, -W1

## M5 (H5)

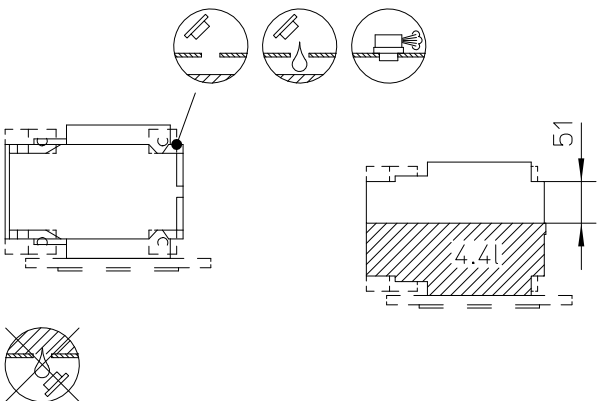

## M6 (H6)

