

S4

M1 (H1)

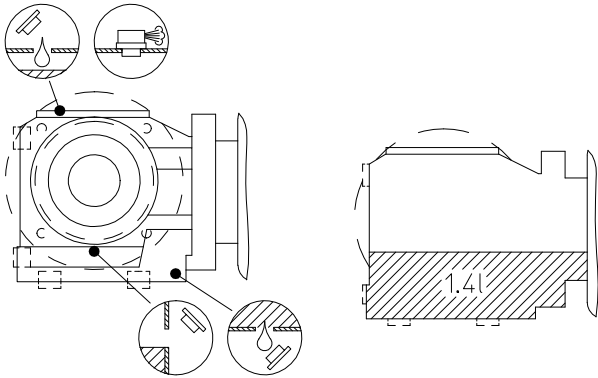

M2 (H4)

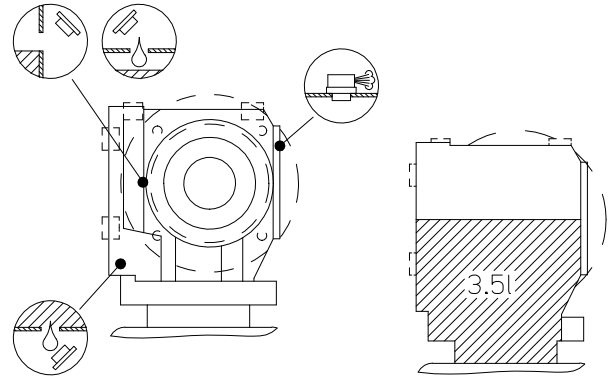

M3 (H2)

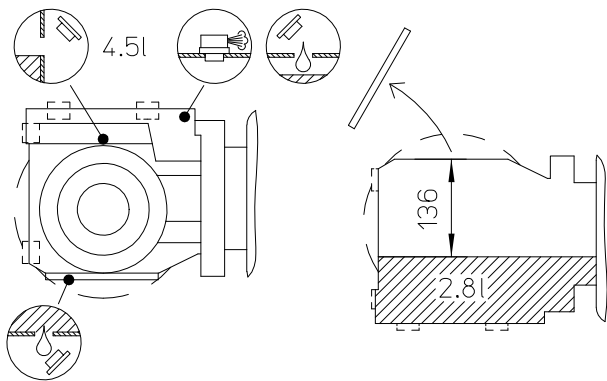

M4 (H3)

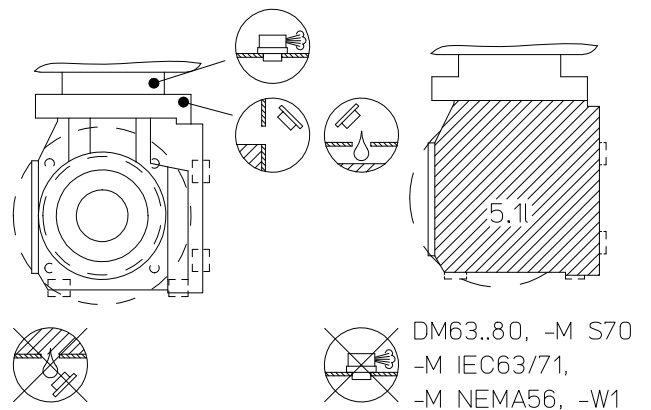

DM63..80, -M S70
-M IEC63/71,
-M NEMA56, -W1

M5 (H5)

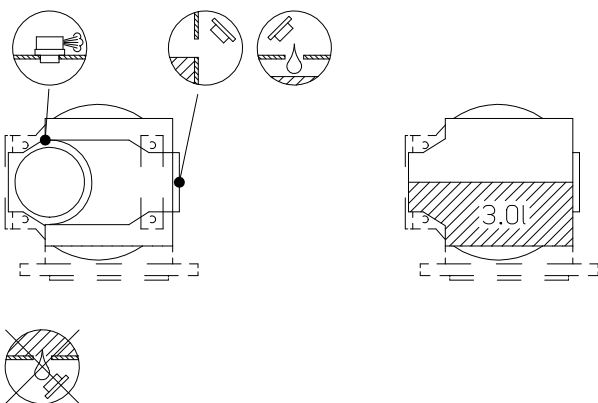

M6 (H6)

